



OPERATING INSTRUCTIONS



dPMR446/PMR446 TRANSCEIVER
IC-F29DR



INTRODUCTION

FOREWORD

Thank you for choosing this Icom transceiver.

IMPORTANT

FIRST, CAREFULLY READ THE INSTRUCTION MANUAL that is provided with the transceiver.

SAVE THESE OPERATING INSTRUCTIONS— These operating instructions contain additional important operating instructions for the **IC-F29DR dPMR446/PMR446 TRANSCEIVER**.

This transceiver includes some functions that are usable only when they are preset by your dealer. Ask your Icom dealer or system operator for details.

TABLE OF CONTENTS

FOREWORD	i	5. dPMR™ OPERATION.....	15
IMPORTANT	i	Receiving and transmitting	15
1. ACCESSORIES	1	◇ Receiving	15
Attaching or detaching accessories	1	◇ Transmitting	16
◇ Battery pack	1	Break-in function.....	17
◇ Belt clip	1	◇ Receiving	17
◇ Jack cover.....	2	◇ Transmitting	17
2. PROGRAMMABLE KEY FUNCTIONS.....	3	Status call	18
Programmable key functions	3	◇ Receiving	18
3. LED INDICATOR.....	5	6. OTHER FUNCTIONS	19
About the LED indicator.....	5	Setting a scan type	19
4. SETTINGS.....	7	Tone Scan function	20
Setting the Beep function	7		
Setting the beep and announcement level	8		
Setting the Call-Ring ringer	9		
Setting the ringer level.....	10		
Setting the microphone gain.....	11		
Setting the squelch level.....	12		
Setting the VOX function	13		
Setting the VOX gain	14		

Icom, Icom Inc. and the Icom logo are registered trademarks of Icom Incorporated (Japan) in Japan, the United States, the United Kingdom, Germany, France, Spain, Russia, Australia, New Zealand, and/or other countries.
dPMR and the dPMR logo are trademarks of the dPMR MoU Association.
All other products or brands are registered trademarks or trademarks of their respective holders.

Section 1 ACCESSORIES

Attaching or detaching accessories

◇ Battery pack

Attach or remove the battery pack, as illustrated to the right.

To attach the battery pack:

- 1) Place the tabs on the bottom of the battery pack into the slots at the bottom of the transceiver. (1)
- 2) Push the battery pack until the battery release buttons make a 'click' sound. (2)

To detach the battery pack:

- 1) Push the battery release buttons in the direction of the arrow as shown to the right. (3)
- 2) The battery pack is then released, and you can remove it. (4)

To attach

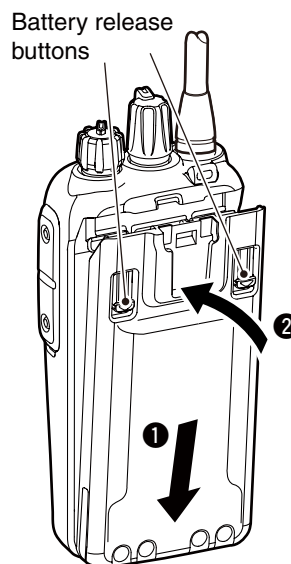

To detach

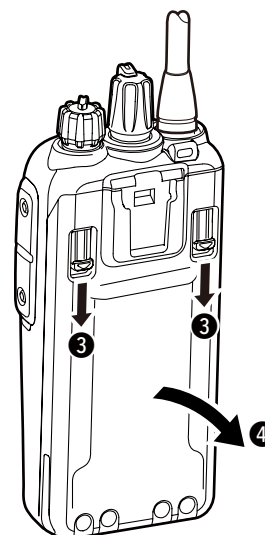

◇ Belt clip

NOTE:

Before attaching or detaching the belt clip, remove the battery pack from the transceiver, if it is attached.

To attach the belt clip:

Slide the belt clip in the direction of the arrow until the belt clip locks in place, and makes a 'click' sound. (1)

To detach the belt clip:

Lift the tab up (2), and slide the belt clip in the direction of the arrow (3).

To attach

To detach

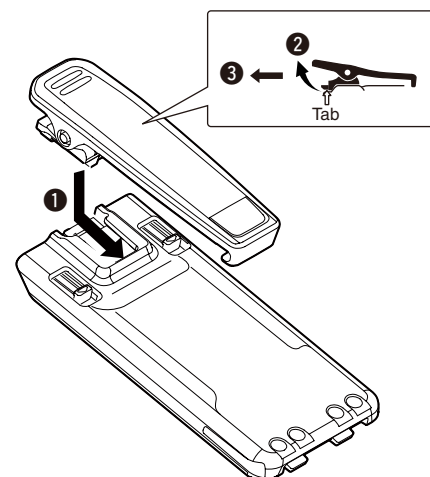

Attaching or detaching accessories (Continued)

◇ Jack cover

CAUTION:

The transceiver meets IP67 requirements for dust-tight and waterproof protection, only when the jack cover or the optional HM-168LWP, HS-94LWP, or HS-95LWP SPEAKER MICROPHONE is attached.

To attach the jack cover:

- 1) Place the jack cover over the speaker-microphone jack. (1)
- 2) Insert and tighten the screws. (2)

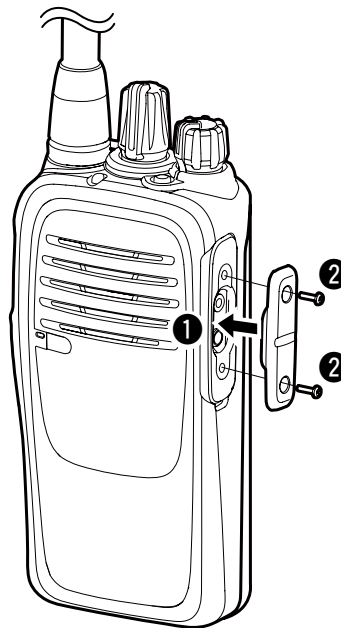

To detach the jack cover:

- 1) Unscrew the screws using a Phillips screwdriver. (3)
- 2) Detach the jack cover. (4)

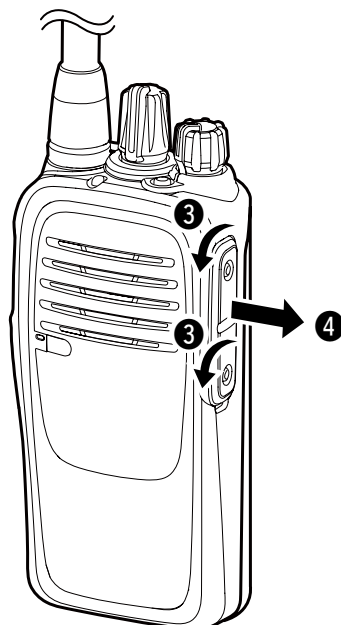

Programmable key functions

You can assign the functions described below to [Top], [Upper], and [Lower] by using the CS-F29DR CLONING SOFTWARE (purchase separately). Ask your dealer for details.

NOTE: See the instruction manual that comes with the transceiver for the default settings of these keys.

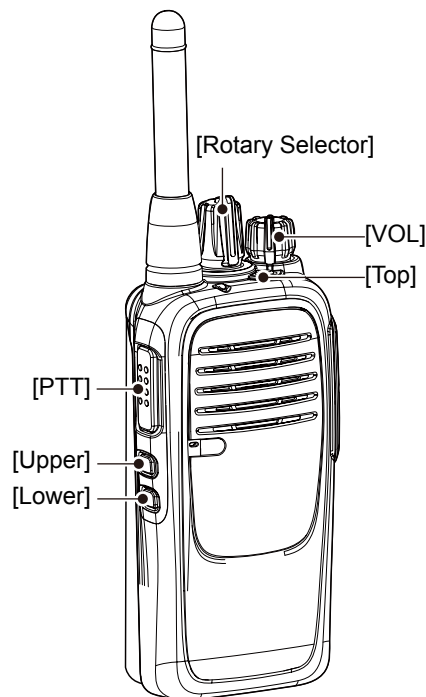

Null

➔ No function is assigned.

ZONE

➔ Push to toggle the operating Zone.

- Each time the user pushes this key, the transceiver selects Zone 1, Zone 2, and then Zone 1 again.

SCAN

NOTE:

Select the channels to be scanned by using CS-F29DR CLONING SOFTWARE.

➔ Push to start or pause a scan.

- When a scan is started with the Power ON Scan or the Automatic scan function, push this key to pause the scan. The paused scan resumes after a set time period.

➔ Hold down this key while a scan is paused, and then the channel is removed from the scan group.

- The removed channel is automatically added to the scan group again, after the scan is canceled.

MONI

➔ While holding down this key, the C.Tone* mute is released, even if the received signal does not include a matching C.Tone*.

* CTCSS tone or DTCS code

LOCK

➔ Hold down to turn the Key Lock function ON or OFF.

- Even when the Key Lock function is ON, [PTT], [MONI], [LOCK], [CALL], [CLEAR], [SURVEILLANCE], and [SIREN] are not locked.

CALL // only on a Digital channel //

➔ Push to make a call that includes a Common ID.

CLEAR // only on a Digital channel //

➔ Push to finish a communication by sending a clear down signal. After the other station receives the clear down signal, the transceiver automatically enters to the Stand-by mode.

BREAK // only on a Digital channel //

➔ Hold down to send a Break-in request call.

- The Break-in request call announces to the other stations on the channel that the user wants to break into the current communication in the group. The transceiver waits for the current communication to end. After the communication ends, the transceiver automatically sends the call.

➔ While waiting, push this key to cancel the Break-in request call.

S-RING/C-RING

// only on an Analog channel //

➔ Push to make a Smart-Ring call.

// on both an Analog and a Digital channel //

➔ Hold down to make a Call-Ring call.

Programmable key functions (Continued)

SURVEILLANCE

- Hold down to turn ON the Surveillance function.
- Push to turn OFF the function.
 - When this function is ON, beeps do not sound and the LED indicator does not light, even when receiving a signal, or pushing a key.

SIREN

- Hold down to sound a siren.
 - This function can be used for purposes other than an Emergency alert, such as a security alarm.
 - The transceiver sounds the siren until the power is turned OFF.

ANNOUNCE

- Push to turn the Channel Announce function ON or OFF.
 - The transceiver announces the position of [Rotary Selector].

SP. FUNC 1/2

- These keys are reserved for future functions. No function is assigned.

Section 3 LED INDICATOR

About the LED indicator

The LED indicator indicates the status of various parameters of the transceiver as follows:
 (Reference: R is Red, G is Green, O is Orange)

- Cloning:
Blinks while reading or writing data.
- Cloning Error:
Blinks if cloning fails.
- Channel Error:
Blinks when you select a blank channel, or an unlocked channel.
- TX low Battery 1:
Blinks while detecting a low battery in the TX mode.
- TX low Battery 2:
Blinks while detecting a very low battery in the TX mode.
- TX:
Lights red while transmitting.
- RX busy:
On an analog channel, lights green when in the noise squelch opens.
On a digital channel, lights green while detecting a frame synchronization.
- Scan:
Blinks while scanning for a channel to search for a signal.
- Low Battery 1:
Blinks slowly when you should charge the battery soon.
- Low Battery 2:
Blinks fast when you must charge the battery.
- Power ON:
Blinks at transceiver startup.
- CH Access:
Blinks while making a Smart-Ring call.
- TX Error:
Blinks when inhibiting transmission (Lockout, TX Inh, or TOT).

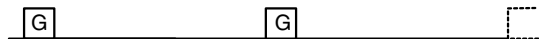
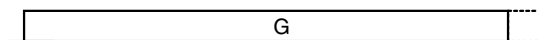
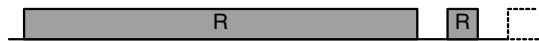
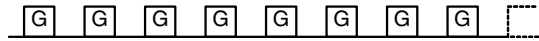

About the LED indicator (Continued)

- **Success:**
On an analog channel, blinks when a Smart-Ring call successful.
On a digital channel, blinks when sending a Break-in request call.

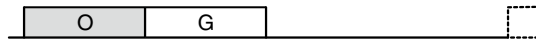

- **Failure:**
Blinks when a Smart-Ring call failed.



- **Siren:**
Blinks while sounding a siren.

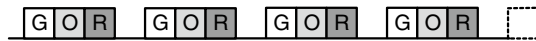

Section 4 SETTINGS

Setting the Beep function

You can turn the Beep function ON or OFF.

NOTE:

Turn ON the Beep function when you set the beep and announcement level, Call-Ring ringer, ringer level, microphone gain, squelch level, VOX function, or VOX gain to check the current level setting by counting or hearing beeps. (pp. 8–14)

- 1) Rotate [VOL] to turn OFF the transceiver power.
- 2) Set [Rotary Selector] to any channel other than Channel 16.
- 3) While holding down [Lower], rotate [VOL] to turn ON the power to enter the Beep Level Adjustment mode.
 - An opening beep sounds and the selected channel number will be announced.
- 4) Push [Lower] to turn the Beep function ON or OFF.
 - When a beep sounds after pushing [Lower], the Beep function is ON.
 - When no beep sounds after pushing [Lower], the Beep function is OFF.

NOTE:

- The transceiver stores the setting every time you change it.
- If desired, push [Upper] to adjust the beep level. See page 8 for details.

- 5) Rotate [VOL] to turn OFF the power and exit the Beep Level Adjustment mode.

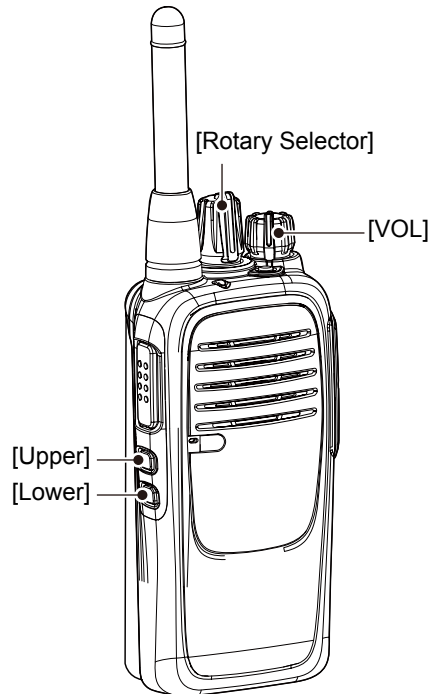

Setting the beep and announcement level

You can adjust the beep and announcement level between 1 and 5, or 1 (linked) and 5 (linked). When a linked option is selected, the beep audio level is adjustable by rotating [VOL].

NOTE:

Turn ON the Beep function (p. 7) before you start setting the beep and announcement level.

- 1) Rotate [VOL] to turn OFF the transceiver.
- 2) Set [Rotary Selector] to any channel other than Channel 16.
- 3) While holding down [Lower], rotate [VOL] to turn ON the power and enter the Beep Level Adjustment mode.
 - An opening beep sounds and the selected channel number will be announced.
- 4) Push [Upper] to change the beep level.
 - A beep sounds every time you push [Upper].

NOTE:

- Repeatedly pushing [Upper] first selects 1 (lowest) to 5 (highest), and then selects the lowest linked level, 1 (Linked) to the highest, 5 (Linked).
- Repeatedly pushing [Upper] repeats the cycle. See the illustration to the right.
- The adjustable range is 1 to 5 or 1 (Linked) to 5 (Linked).
- A beep sounds every time you push [Upper]. Therefore, you can determine the current level setting by the increasing loudness of the beep that sounds.
- To determine if you have selected a linked level, set [VOL] to minimum, then push [Upper] repeatedly, listening for the loudest beep (level 5). Pushing [Upper] once after the loudest beep will select 1 (Linked). Repeatedly push [Upper] to select the desired linked level.

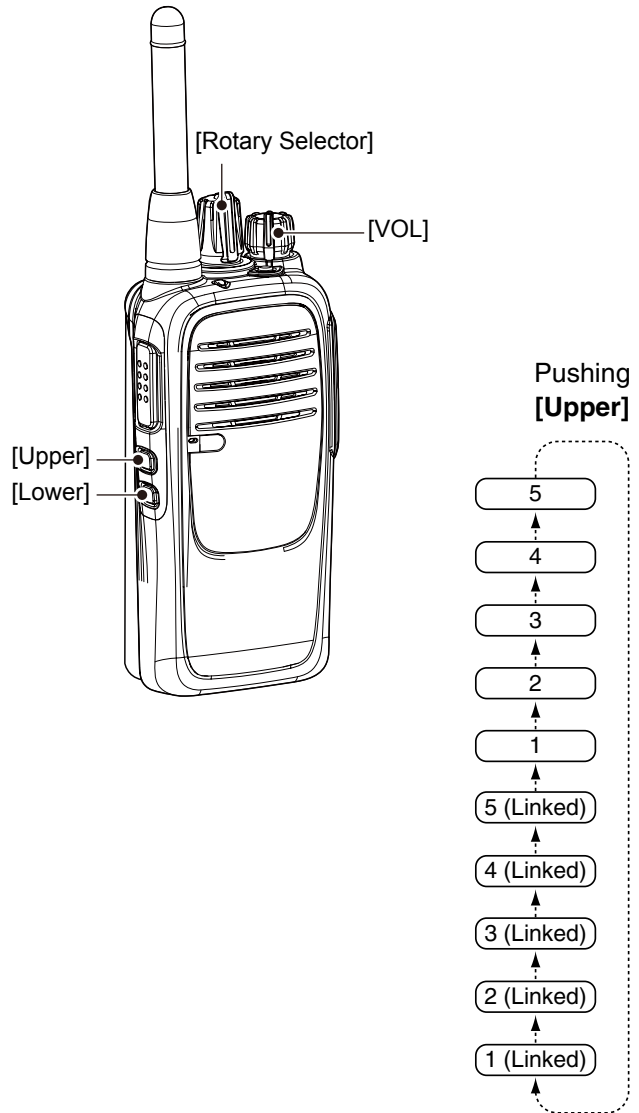

- 5) Rotate [VOL] to turn OFF the power and exit the Beep Level Adjustment mode.

Setting the Call-Ring ringer

The Call-Ring ringer sounds only when the user holds down [S-Ring/C-Ring] to make a call.

NOTE:

Turn ON the Beep function (p. 7) before you start setting the Call-Ring ringer.

- 1) Rotate [VOL] to turn OFF the power.
- 2) Set [Rotary Selector] to any channel other than Channel 16.
- 3) While holding down [PTT] and [Lower], rotate [VOL] to turn ON the power and enter the Call-Ring ringer setting mode.
 - The current Call-Ring ringer sounds.
- 4) Rotate [Rotary Selector] to select a desired Call-Ring ringer.
 - The selected Call-Ring ringer sounds.
- 5) Rotate [VOL] to turn OFF the power and exit the Call-Ring ringer setting mode.

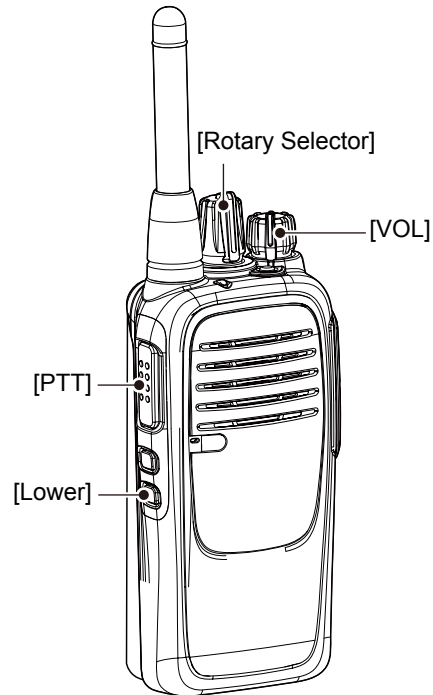

Setting the ringer level

You can adjust the ringer level between 1 and 5, or 1 (Linked) and 5 (Linked). When a linked option is selected, the ringer audio level is adjustable by rotating [VOL].

NOTE:

Turn ON the Beep function (p. 7) before you start setting the ringer level.

- 1) Rotate [VOL] to turn OFF the transceiver power.
- 2) Set [Rotary Selector] to Channel 16.
- 3) While holding down [Lower], rotate [VOL] to turn ON the power and enter the Ringer Level Adjustment mode.
 - An opening beep sounds and “Sixteen” will be announced.
- 4) Push [Upper] to increase, or push [Lower] to decrease the ringer level.
 - A beep sounds after pushing [Upper] or [Lower].

NOTE:

- Repeatedly pushing [Upper] first selects 1 (lowest) to 5 (highest), and then selects the lowest linked level, 1 (Linked) to the highest, 5 (Linked). Repeatedly pushing [Upper] or [Lower] repeats the cycle. See the illustration to the right.
- The adjustable range is 1 to 5 or 1 (Linked) to 5 (Linked).
- A beep sounds after pushing [Upper] or [Lower]. Therefore, you can determine the current level setting by the increasing or decreasing loudness of the beep that sounds.
- To determine if you have selected a linked level, set [VOL] to minimum, then push [Upper] up to 10 times, listening for the loudest beep (level 5). Pushing [Upper] once after the loudest beep will select 1 (Linked). Repeatedly push [Upper] or [Lower] to select the desired linked level.

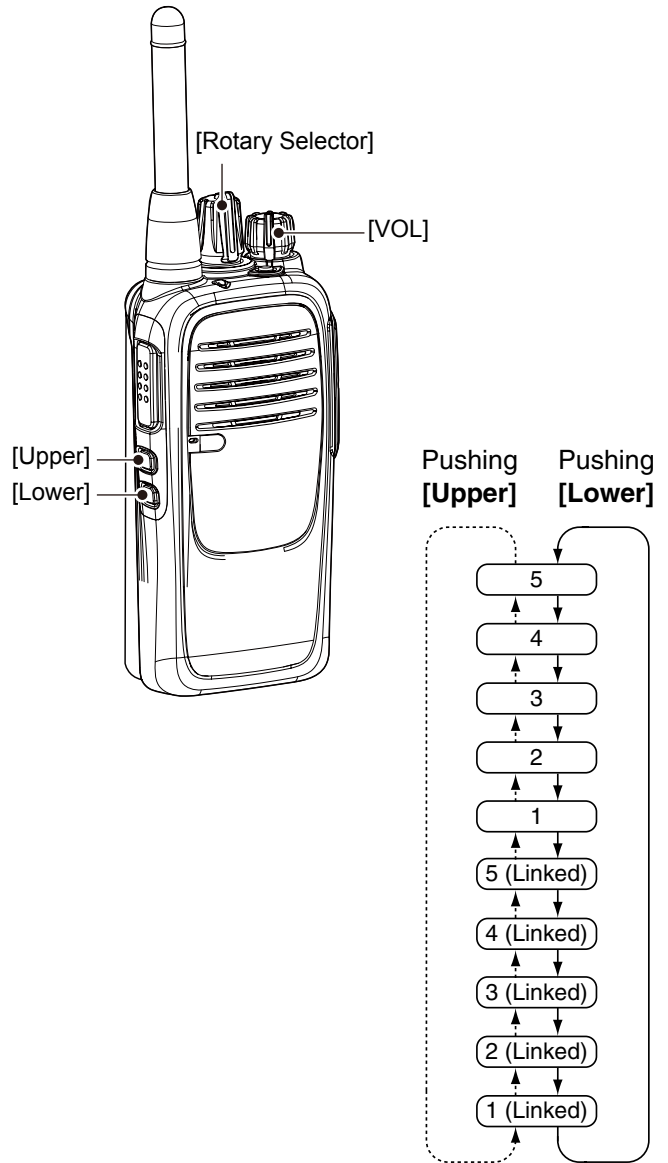

- 5) Rotate [VOL] to turn OFF the power and exit the Ringer Level Adjustment mode.

Setting the microphone gain

You can adjust the microphone gain. Higher values make the microphone more sensitive to the user voice.

NOTE:

Turn ON the Beep function (p. 7) before you start setting the microphone gain.

- 1) Rotate [VOL] to turn OFF the transceiver power.
- 2) Set [Rotary Selector] to Channel 16.
- 3) While holding down [Upper], rotate [VOL] to turn ON the power and enter the Microphone Gain Adjustment mode.
 - An opening beep sounds and "Sixteen" will be announced.
- 4) Push [Upper] to increase, or push [Lower] to decrease the microphone gain.
 - A beep sounds after pushing [Upper] or [Lower].

NOTE:

- The adjustable range is 1 (minimum) to 4 (maximum).
- A beep sounds after pushing [Upper] or [Lower]. An error beep sounds if you try to exceed the adjustable range.

- 5) Rotate [VOL] to turn OFF the power and exit the Microphone Gain Adjustment mode.

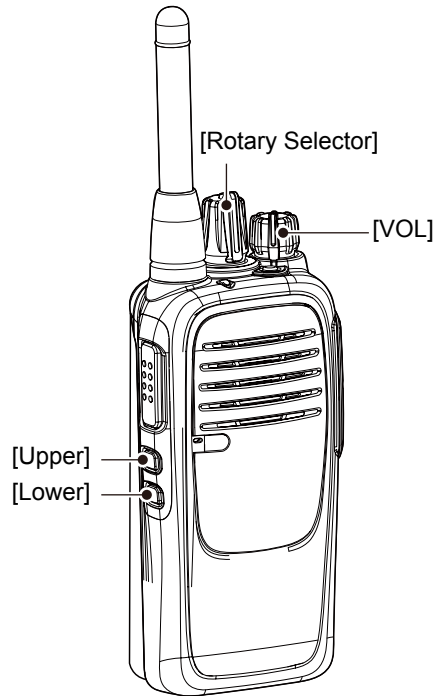

Setting the squelch level

You can adjust the squelch level. The squelch circuit mutes the received audio signal, depending on the signal strength.

NOTE:

Turn ON the Beep function (p. 7) before you start setting the squelch level.

- 1) Rotate [VOL] to turn OFF the transceiver power.
- 2) Set [Rotary Selector] to any channel other than Channel 16.
- 3) While holding down [Upper], rotate [VOL] to turn ON the power and enter the Squelch Level Adjustment mode.
 - An opening beep sounds and the selected channel number will be announced.
- 4) Push [Upper] to increase the squelch level (tight squelch), or push [Lower] to decrease the squelch level (loose squelch).
 - A beep sounds after pushing [Upper] or [Lower].

NOTE:

- The adjustable range is 0 (loose squelch) to 9 (tight squelch).
- A beep sounds after pushing [Upper] or [Lower]. An error beep sounds if you try to exceed the adjustable range.

- 5) Rotate [VOL] to turn OFF the power and exit the Squelch Level Adjustment mode.

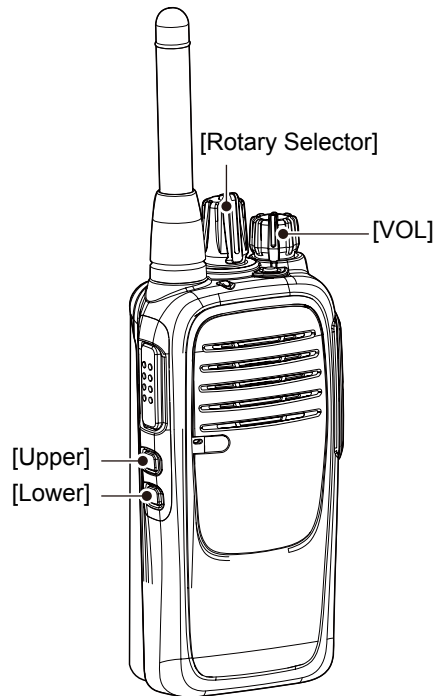

Setting the VOX function

You can turn the VOX function ON or OFF. The VOX function automatically switches between receive and transmit during voice operation.

NOTE:

Turn ON the Beep function (p. 7) before you start setting the VOX function.

- 1) Rotate [VOL] to turn OFF the transceiver power.
- 2) Set [Rotary Selector] to any channel other than Channel 16.
- 3) While holding down [PTT] and [Upper], rotate [VOL] to turn ON the power, to turn the VOX function ON or OFF.
 - When the VOX function is ON, an opening beep and a beep sounds, and then the selected channel number will be announced.
 - When the VOX function is OFF, an opening beep and two beeps sound, and then the selected channel number will be announced.
- 4) Rotate [VOL] to turn OFF the power, then turn ON again to restart normal operation.

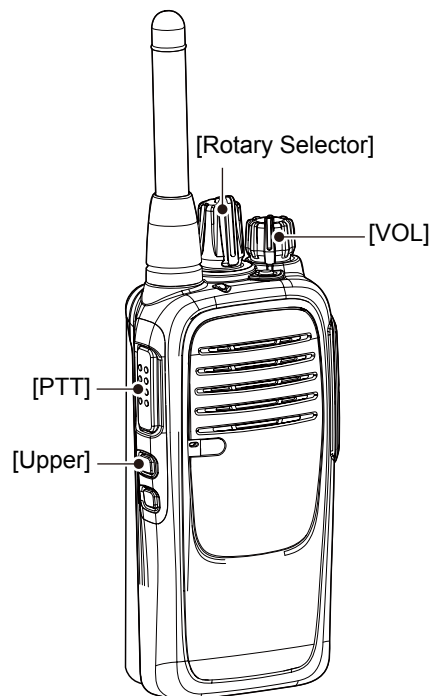

Setting the VOX gain

You can adjust the VOX gain. Higher values make the VOX function more sensitive to the user voice.

NOTE:

Turn ON the Beep function (p. 7) before you start setting the VOX gain.

- 1) Rotate [VOL] to turn OFF the transceiver power.
- 2) Set [Rotary Selector] to Channel 16.
- 3) While holding down [PTT] and [Upper], rotate [VOL] to turn ON the power and enter the VOX Gain Adjustment mode.
 - An opening beep sounds and “Sixteen” will be announced.
- 4) Push [Upper] to increase, or push [Lower] to decrease the VOX gain.
 - A beep sounds after pushing [Upper] or [Lower].

NOTE:

- The adjustable range is 1 (minimum) to 10 (maximum).
- A beep sounds after pushing [Upper] or [Lower]. An error beep sounds if you try to exceed the adjustable range.

- 5) Rotate [VOL] to turn OFF the power and exit the VOX Gain Adjustment mode.

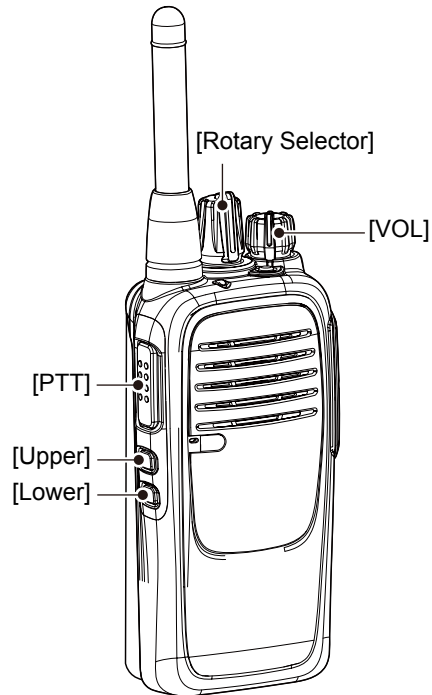

Receiving and transmitting

◇ Receiving

- 1) Rotate [Rotary Selector] to select a channel.
- 2) When receiving a call, rotate [VOL] to adjust the audio.

NOTE:

When a call is received:

- Beeps sound, and the mute is released.
- The LED indicator lights green.

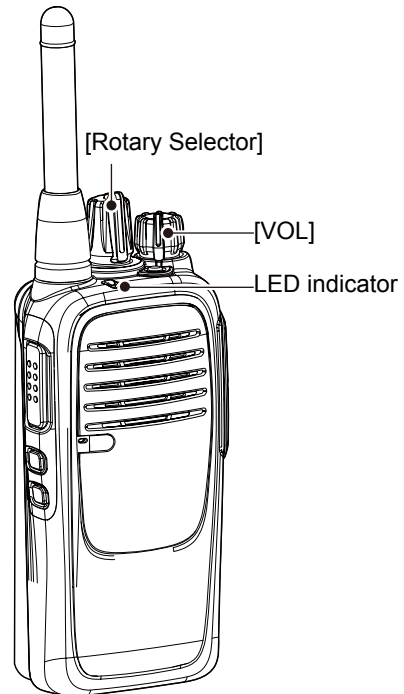

Receiving and transmitting (Continued)

◇ **Transmitting**

You can make a call to a station that has the same Common ID. Other digital mode transceivers on the channel will not receive the call that does not match their Common ID.

Before making a call, wait until the channel is clear to avoid interference.

Using [PTT]:

- 1) Rotate [Rotary Selector] to select a channel.
- 2) Push [PTT] to call a station.
- 3) Hold down [PTT] and speak at your normal voice level.
- 4) Release [PTT] to receive.
- 5) Push [Clear]* to send a 'Disconnect' signal to terminate the call.

Using the [S-Ring/C-Ring]:

- 1) Rotate [Rotary Selector] to select a channel.
- 2) Hold down [S-Ring/C-Ring] for 1 second to call a station.
- 3) Hold down [PTT] and speak at your normal voice level.
- 4) Release [PTT] to receive.
- 5) Push [Clear]* to send a 'Disconnect' signal to terminate the call.

Using the [Call]*:

- 1) Rotate [Rotary Selector] to select a channel.
- 2) Push [Call]* to send a call request.

NOTE:

After receiving a call request, a ringer sounds on a receive transceiver.

- 3) Hold down [PTT] and speak at your normal voice level.
- 4) Release [PTT] to receive.
- 5) Push [Clear]* to send a 'Disconnect' signal to terminate the call.

* Assign the function to a programmable key by using the CS-F29DR cloning software (purchase separately). Ask your dealer for details.

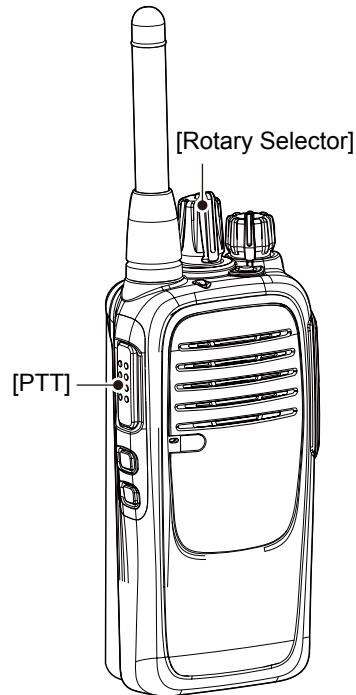

NOTE:

To insure the readability of your signal:

1. After pushing [PTT], pause briefly before you start speaking.
2. Hold the microphone 5 to 10 cm from your mouth, and then speak at your normal voice level.

Break-in function

You can send a Break-in request call.
 The Break-in request call announces to the other stations on the channel that the user wants to break into the current communication in the group.
 The transceiver waits for the current communication to end, and then sends the call.

◆ Receiving

- 1) When receiving a Break-in request call, the ringer sounds, and the LED indicator blinks orange.
- 2) Push any key to stop the ringer sounding and the LED blinking.

◆ Transmitting

- While receiving an audio signal, hold down [Break]* for 1 second to send a Break-in request call.

NOTE:

- The transceiver waits for the communication to end, and then sends the call.
- To cancel the Break-in request call, push [Break]* while waiting.

* Assign the function to a programmable key by using the CS-F29DR cloning software (purchase separately). Ask your dealer for details.

Example: Station A, B, and C are communicating using the same Common ID.

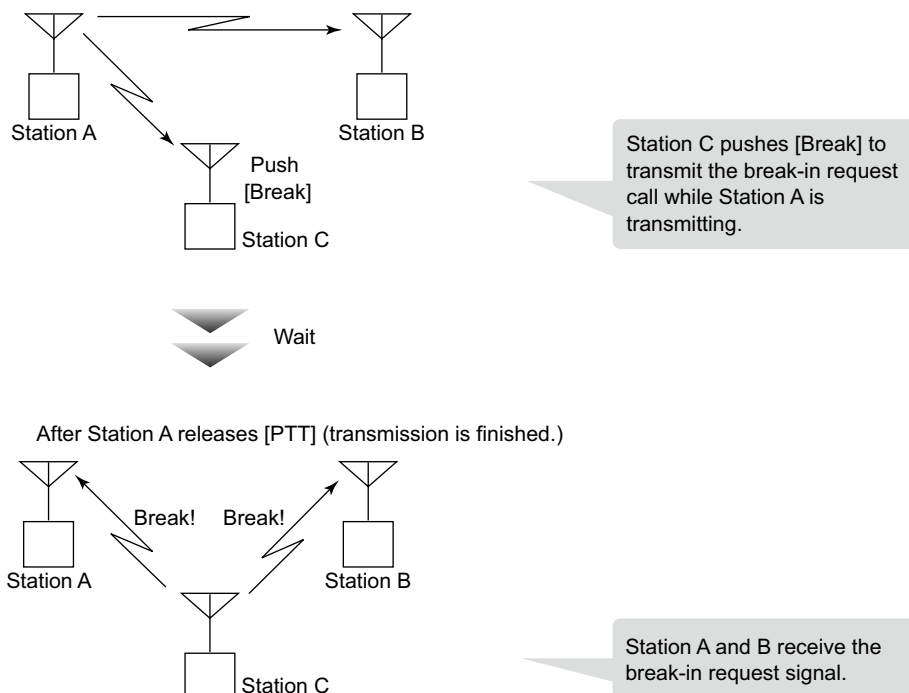

Status call

◇ Receiving

- ➔ When receiving a Status message, the ringer sounds and the LED indicator status changes, according to the presetting. Ask your dealer for details.

NOTE:

You cannot send a Status call with the IC-F29DR.

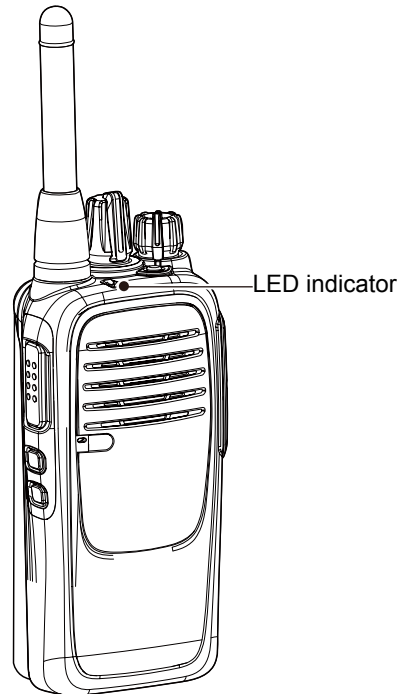

Section 6 OTHER FUNCTIONS

Setting a scan type

You can set to whether the transceiver scans all channels across the zone (All), or scans channels in a selected zone (Zone).

NOTE:

Turn ON the Beep function (p. 7) before you start setting a scan type.

- 1) Rotate [VOL] to turn OFF the transceiver power.
- 2) Set [Rotary Selector] to Channel 16.
- 3) While holding down [PTT], rotate [VOL] to turn ON the power, to set a scan type.
 - When you set to "All," an opening beep and a beep sounds, and the selected channel number will be announced.
 - When you set to "Zone," an opening beep and two beeps sound, and the selected channel number will be announced.
- 4) Rotate [VOL] to turn OFF the power, then turn ON again to restart normal operation.

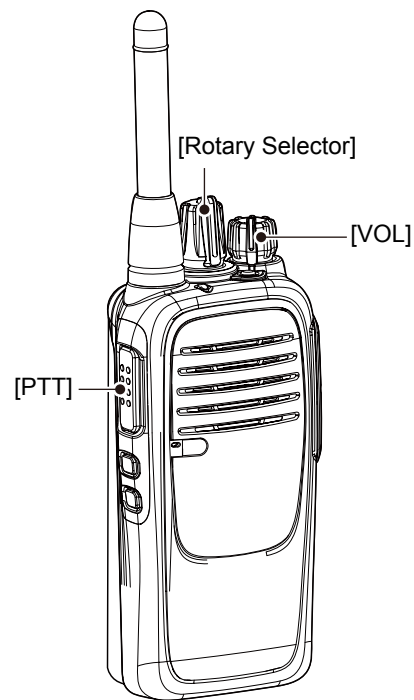

Tone Scan function

This function is effective when the user wants to communicate with another station but does not know its CTCSS tone or DTCS code setting.*

* Depending on the presetting. Ask your dealer for details.

NOTE:

Turn ON the Beep function (p. 7) before you enter the Tone Scan mode.

- 1) Rotate [VOL] to turn OFF the power.
- 2) Set [Rotary Selector] to any channel other than Channel 16.
- 3) While holding down [Upper] and [Lower], rotate [VOL] to turn ON the power and enter the Tone Scan mode.
 - An opening beep sounds and the current channel number will be announced. (Example: Ten)
- 4) Rotate [Rotary Selector] to select a desired channel that you want to assign the detected CTCSS tone or DTCS code to.
 - The selected channel number will be announced.
- 5) Hold down [Upper] for 1 second to start a scan.
 - The LED indicator blinks green slowly.
- 6) When detecting a matching tone or code, the scan pauses, and the tone or code is automatically set to the channel.
- 7) Push [Upper] to cancel the scan.

NOTE:

The scan resumes 3 seconds (default) after the signal disappears.

- 8) Rotate [VOL] to turn OFF the power and exit the Tone Scan mode.

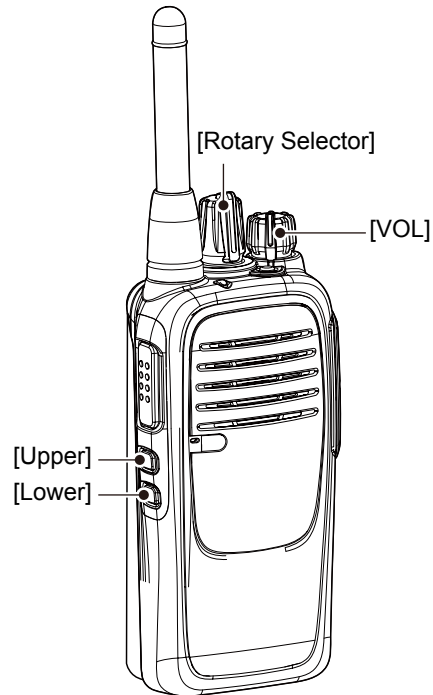

Count on us!

